



GripTM

durable solution

Adin presents the new Grip™ overdenture attachment as an addition to our wide variety of prosthetic solutions.

Implant supported overdentures are among the most practical prosthetic solutions for patients who cannot utilize fixed restorations, or as an interim solution for patients who are waiting for the osteointegration process of their newly placed implants.

The Grip™ attachment system is a versatile solution, designed to ensure maximum denture retention and stability both for maxillary and mandibular dentures. The variety of retentive caps allow dentists to choose the required retention level needed for each individual case and can easily be replaced, when needed.

The Grip™ attachment system is available for Internal Hex & Conical connection platforms (excluding UNP), in a range of gingival heights, to enable a reliable, long lasting and cost-effective solution for your patients.

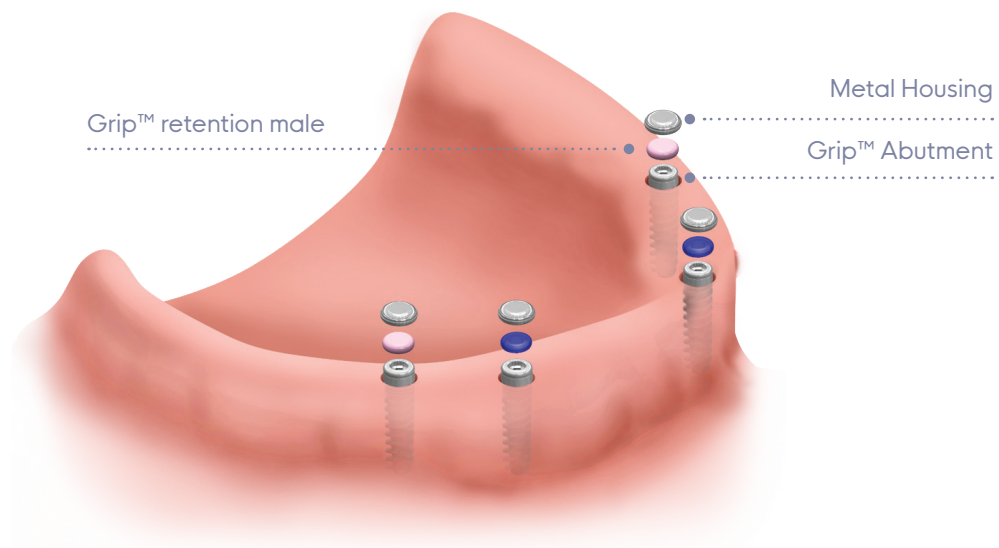

Benefits

- The low profile of the Grip™ attachments are ideal for vertical space limitations.
- The flexibility of the caps prevents overloading of implants, lowering the risk of damaging the implants.
- Grip™ attachments' angle compensation design to enable use in non-parallel implants up to 40°, making it a perfect and flexible solution.
- Variety of retentions in different hardness levels to fit any clinical need.
- Quick & easy handling of the denture.

Selection

Based on the results of the patient's pre-surgical assessment, the dentist should select and order the appropriate Grip™ abutment, based on the type of implant, diameter, and tissue height (GH).

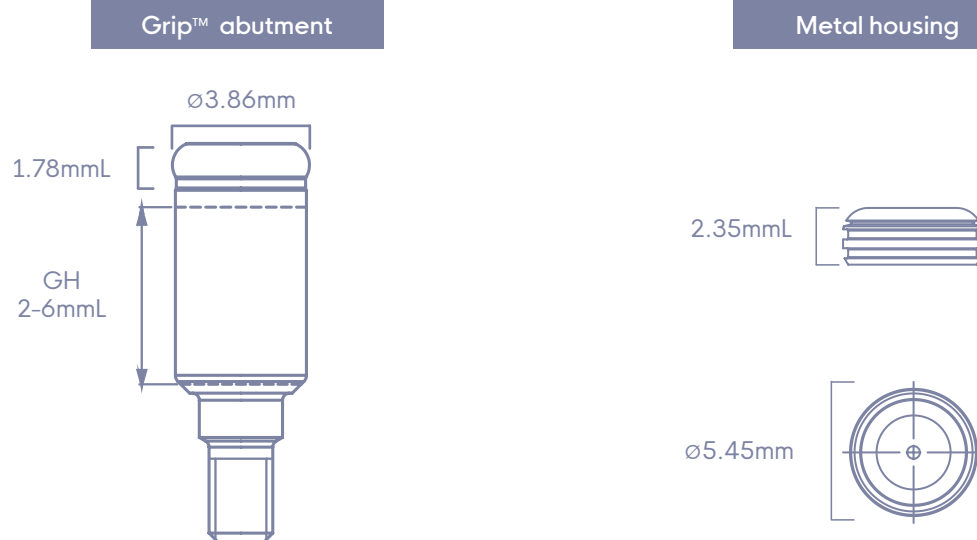

Retention

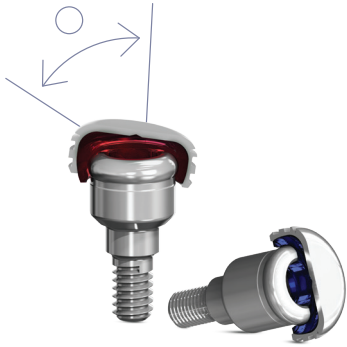

The **Grip™** implant attachment system was designed with customizable levels of retention:

Dual retention, pivoting action provides resiliency to maximize stability and longevity up to 20°

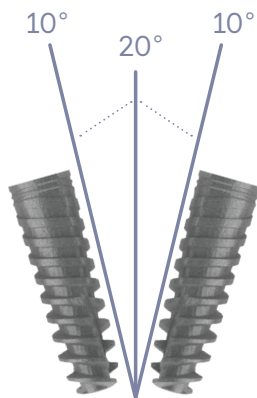

Extended range male's pivoting action engineered to allow insertion with up to 40° total divergence

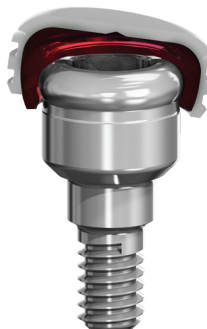
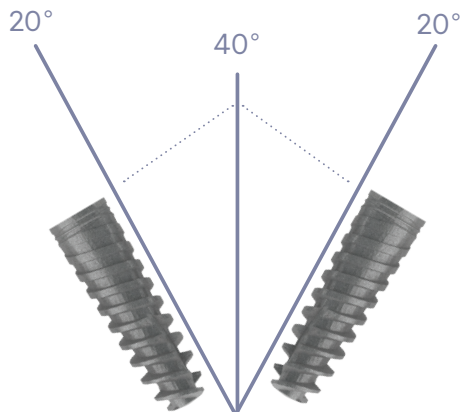



Touareg™ | Internal Hex

One connection



| | |
|----------------------|--------|
| Grip RS Abutment 1mm | RS3037 |
| Grip RS Abutment 2mm | RS3032 |
| Grip RS Abutment 3mm | RS3033 |
| Grip RS Abutment 4mm | RS3034 |
| Grip RS Abutment 5mm | RS3035 |
| Grip RS Abutment 6mm | RS3036 |



UniFit™ | Unified Conical Connection



| | |
|----------------------|--------|
| Grip UF Abutment 1mm | UF0101 |
| Grip UF Abutment 2mm | UF0102 |
| Grip UF Abutment 3mm | UF0103 |
| Grip UF Abutment 4mm | UF0104 |
| Grip UF Abutment 5mm | UF0105 |
| Grip UF Abutment 6mm | UF0106 |

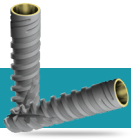

NP™ | Conical Connection

Narrow platform

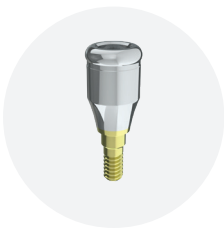

Grip NP Abutment 1mm **NP0051**

Grip NP Abutment 2mm **NP0052**

Grip NP Abutment 3mm **NP0053**

Grip NP Abutment 4mm **NP0054**

Grip NP Abutment 5mm **NP0055**

Grip NP Abutment 6mm **NP0056**

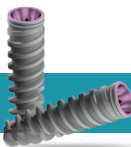

RP™ | Conical Connection

Regular platform



Grip RP Abutment 1mm **RP0038**

Grip RP Abutment 2mm **RP0057**

Grip RP Abutment 3mm **RP0058**

Grip RP Abutment 4mm **RP0059**

Grip RP Abutment 5mm **RP0060**

Grip RP Abutment 6mm **RP0061**

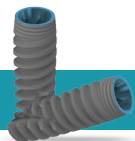

WP™ | Conical Connection

Wide platform



| | |
|----------------------|---------------|
| Grip WP Abutment 1mm | WP0063 |
| Grip WP Abutment 2mm | WP0057 |
| Grip WP Abutment 3mm | WP0058 |
| Grip WP Abutment 4mm | WP0059 |
| Grip WP Abutment 5mm | WP0060 |
| Grip WP Abutment 6mm | WP0061 |



Grip™ components

Metal housing 

Grip™ retention 

Grip™ extended range retention 

Grip™ abutment retention 

Grip™ for TMA  TM0100
*Intended to be used with the Grip™ extended range retention only

Grip™ for Bar, M2 thread  RS0101

Grip™ system components For Impression and fabrication process

Impression coping  RS6414

Lab grip retention  RS6416

Block out spacer  RS6424

Replica  RS2508

Grip™ core tool

Designed for inserting and removing the Grip™ retention males from the metal housing

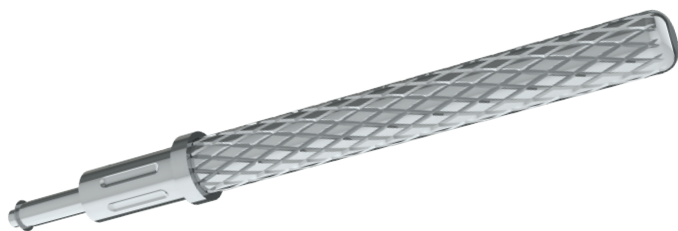

Grip core tool

RS6200

RS Internal Hex connection



1.27 Hex hand driver-medium

RS6094



1.27 Hex torque driver-long

RS6082



1.27 Hex driver for handpiece - long

RS9035



1.27 Hex hand driver-short

RS6095



1.27 Hex torque driver-short

RS6080



1.27 Hex driver for handpiece - short

RS9030

UniFit™ and CloseFit™ Conical connection all platforms



Star Hand Driver Long

RP0004



Star Torque Driver 25.4mm

RP0005



Star Handpiece Drive 30mm

RP0019



Star Hand Driver Short

RP0064



Star Torque Driver 20.4mm

RP0065



Star Handpiece Driver 25mm

RP0018



*For Angled TMA/TMA prosthetic screw



Sales Pack

| | | |
|---|-------------------------|--------|
|  | Metal housing 4 pack | RS6413 |
|---|-------------------------|--------|

| | | | | | |
|---|---|---|-------------|--------------------------|--------|
|  |  |  | extra light | Grip Retention 4 pack | RS6417 |
| | |  | light | | RS6418 |
| | |  | regular | | RS6419 |

| | | | | | |
|---|---|---|-------------|--|--------|
|  |  |  | zero | Grip Extended Range Retention 4 pack | RS6420 |
| | |  | extra light | | RS6421 |
| | |  | light | | RS6422 |
| | |  | regular | | RS6423 |

| | | |
|---|-------------------------------------|--------|
|  | Grip Impression coping 4 pack | RS6414 |
|  | Grip Processing 4 pack | RS6415 |
| | Grip Processing 20 pack | RS6416 |

| | | |
|---|------------------------------------|--------|
|  | Grip Replica 4 pack | RS2508 |
|  | Grip Block out spacer 4 pack | RS6424 |

| | | | | |
|---------------------|---|------------------|---|--------|
| Grip processing set |  | housing |  | RS6426 |
| |  | processing | | |
| |  | extra light | | |
| |  | light | | |
| |  | regular | | |
| |  | block out spacer | | |

| | | | | |
|------------------------------------|---|------------------|---|--------|
| Grip Extended Range processing set |  | housing |  | RS6427 |
| |  | processing | | |
| |  | zero | | |
| |  | extra light | | |
| |  | light | | |
| |  | regular | | |
| |  | block out spacer | | |

| | | | | |
|---------------------|---|------------------|---|--------|
| Grip processing set |  | housing |  | RS6428 |
| |  | processing | | |
| |  | extra light | | |
| |  | light | | |
| |  | block out spacer | | |

About Adin

Every business starts with a vision.

Ours is simple: We want to create the best possible dental implant solutions that offer uncompromising quality at an affordable price. It's our people that help our business thrive and grow. That's why we place so much importance on building strong personal relationships that enable us to meet our doctors and distributors' needs. Understanding that their success is our success, we're focused on providing professional, high quality and affordable solutions and exceptional service that help them grow.

